

Transformers

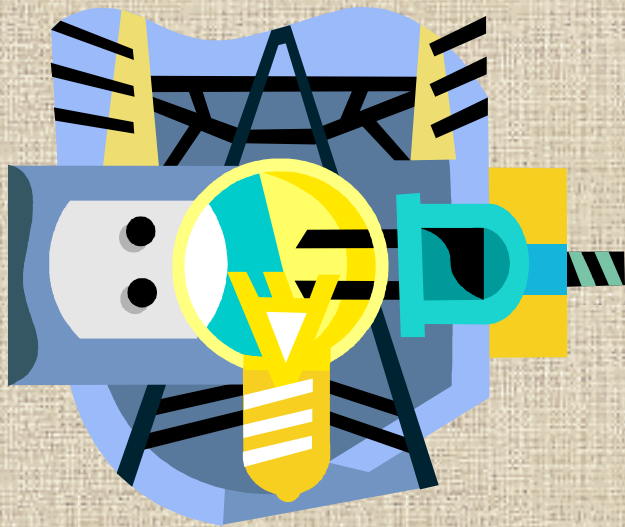

Transformer Ratings

- VA rating
- Cooling
 - 1000 kVA 55°C ONAN
- Frequency
- Voltage
- Phase

Separate Windings

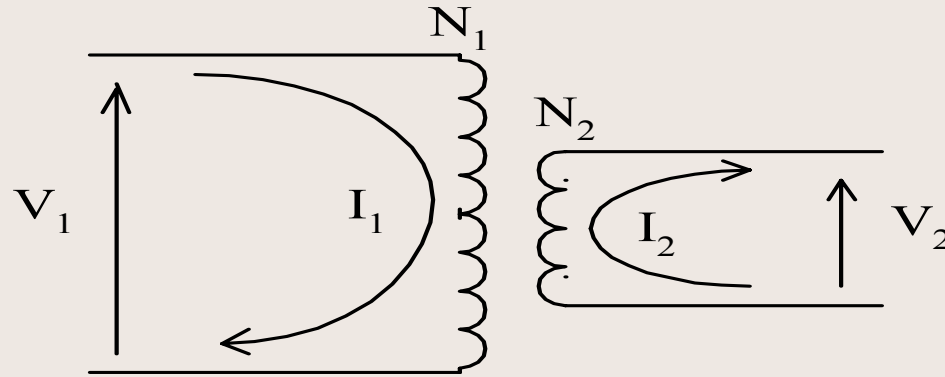

$$\frac{V_2}{V_1} = \frac{N_2}{N_1} = \frac{I_1}{I_2}$$

Autotransformer

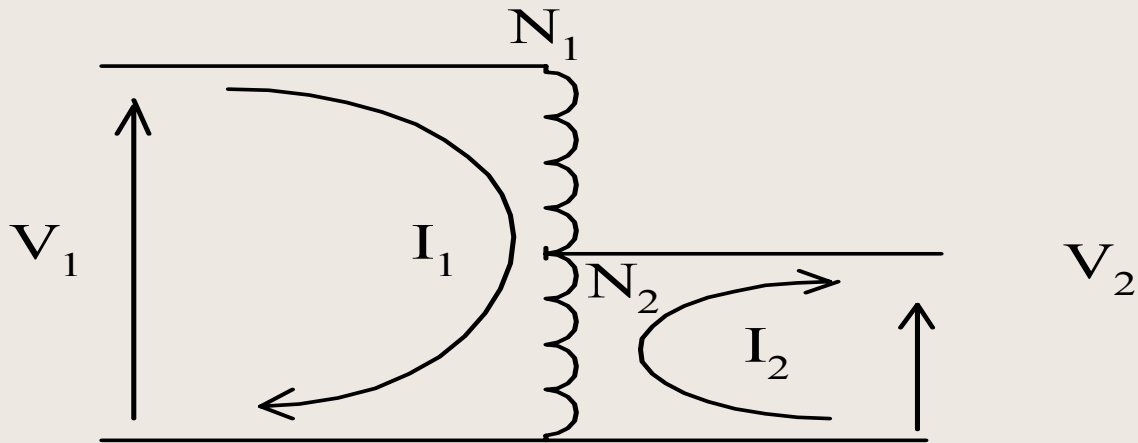

$$\frac{V_2}{V_1} = \frac{N_2}{N_1} = \frac{I_1}{I_2}$$

Connections

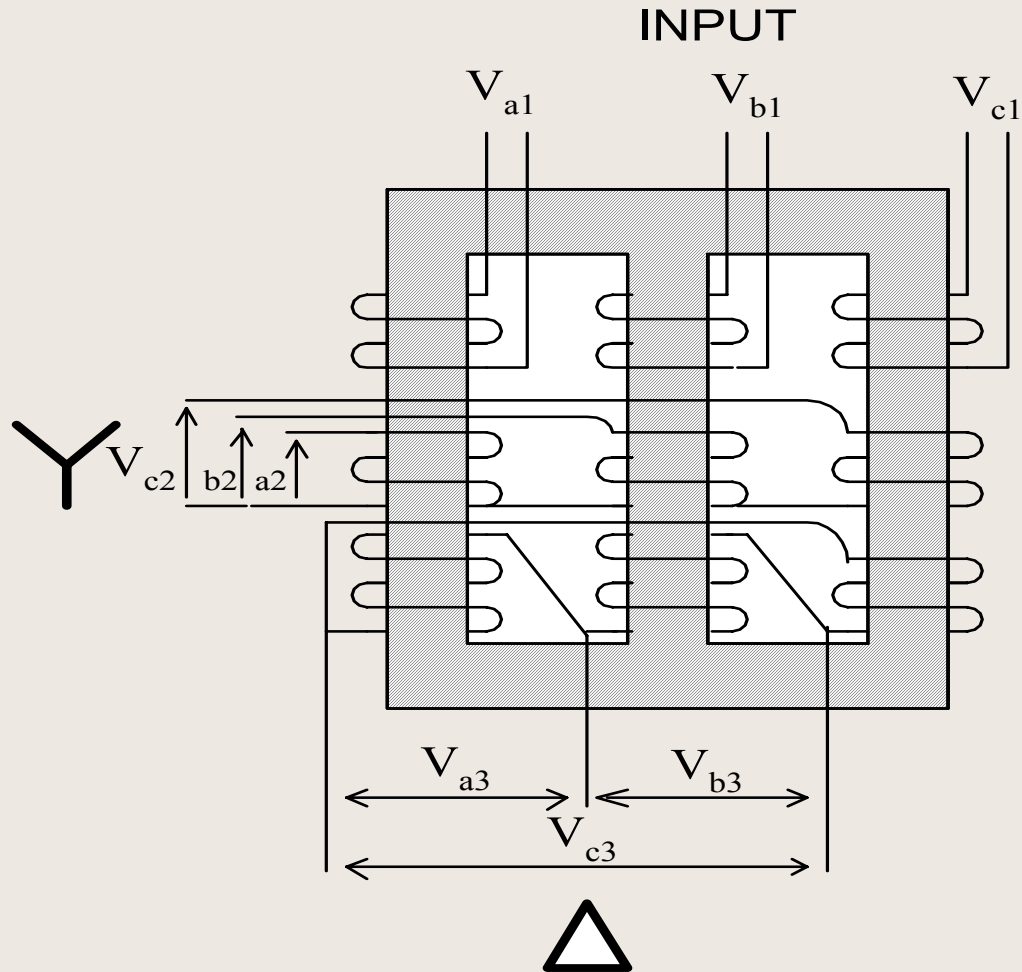

Off Load Tap Changers

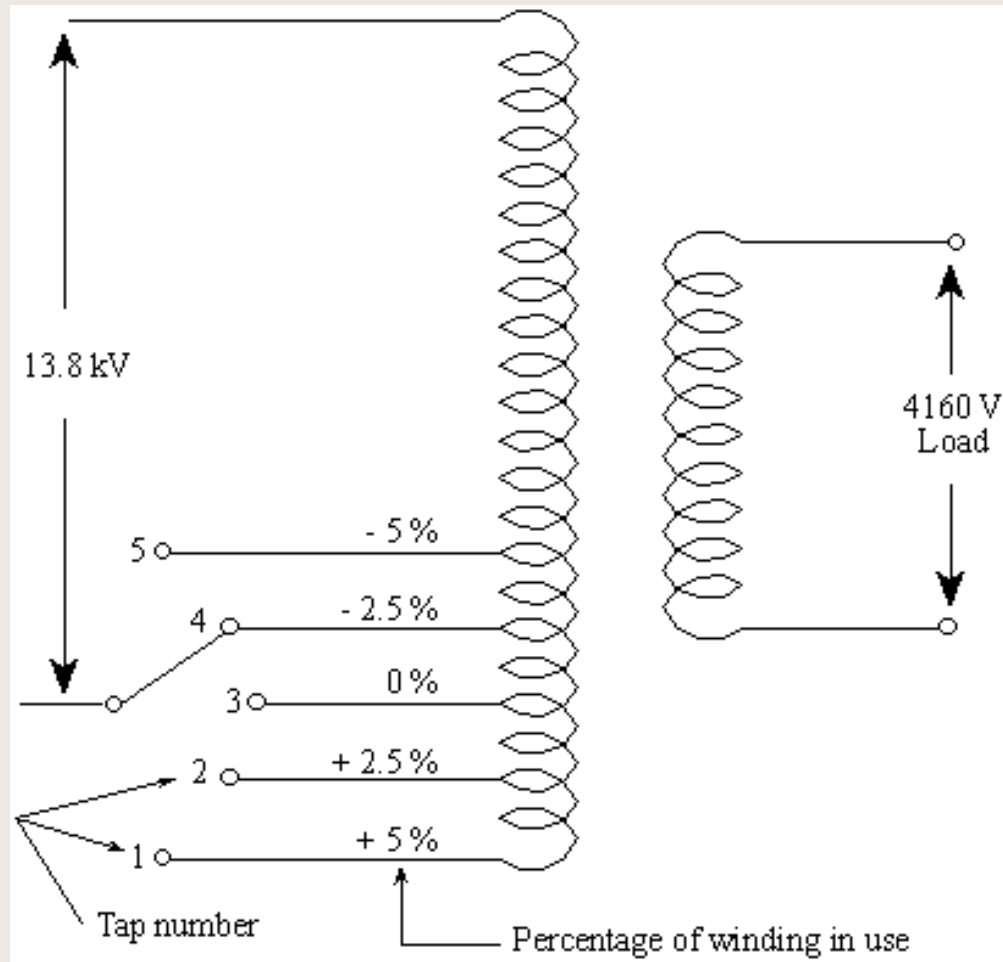

On Load Tap-Changers

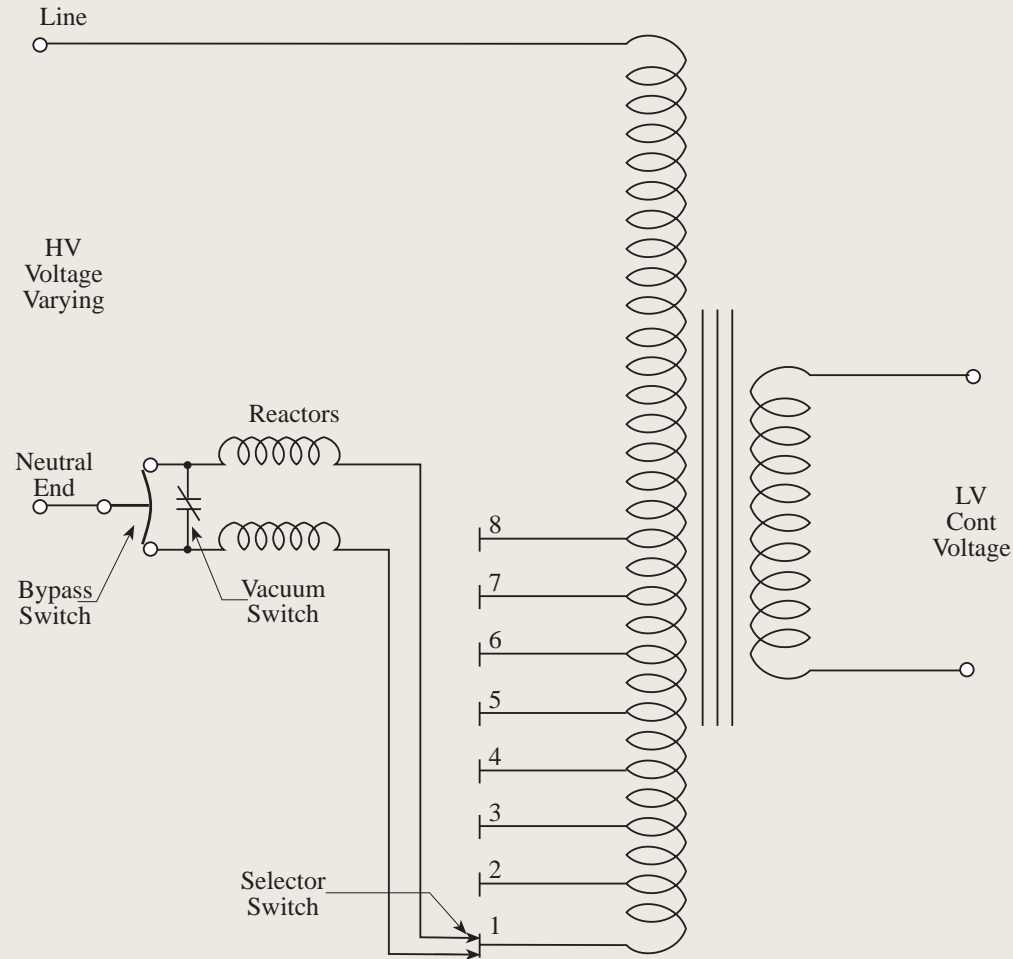

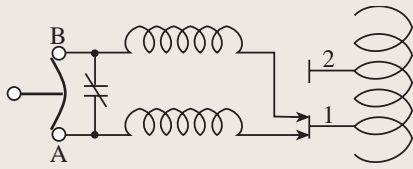

(1)

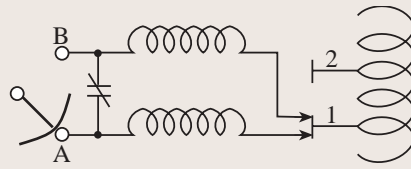

(2)

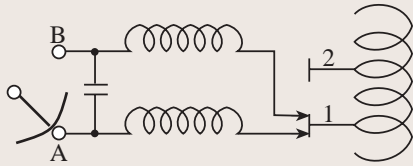

(3)

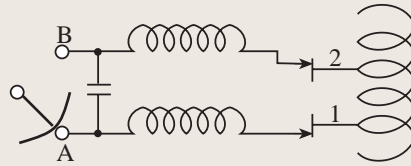

(4)

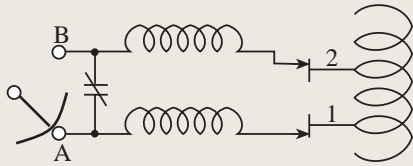

(5)

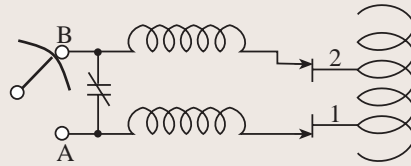

(6)

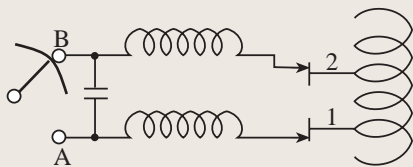

(7)

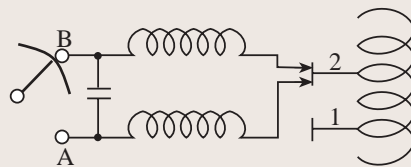

(8)

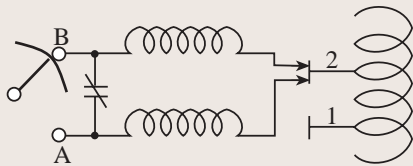

(9)

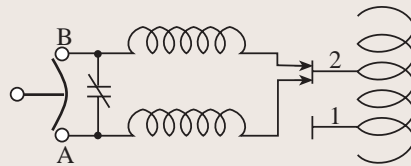

(10)

Tap-Changer Sequence of Operation

Transformer Losses

- No-Load
 - Hysteresis
 - Eddy Currents
 - A tiny winding loss due to exciting current
- Winding Losses
 - Vary with the square of the load

Copper Losses

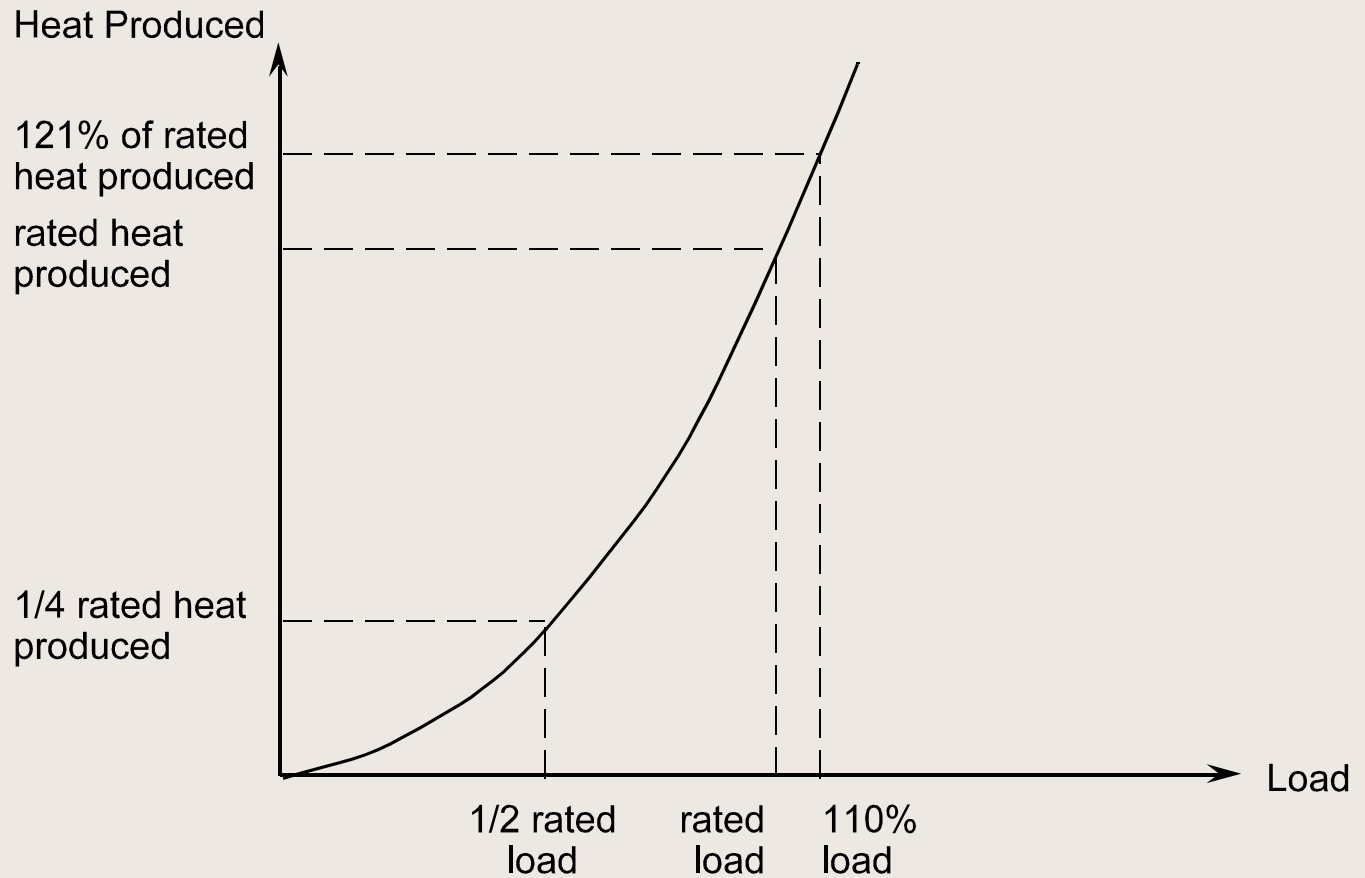

Core Losses

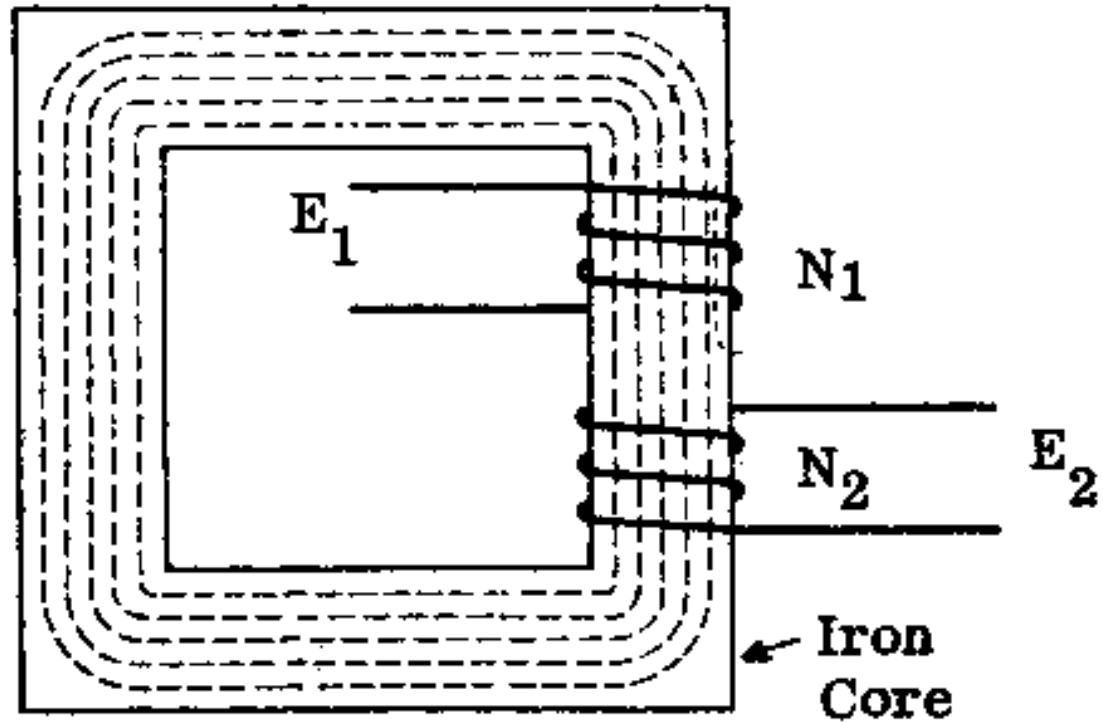

Laminated Core

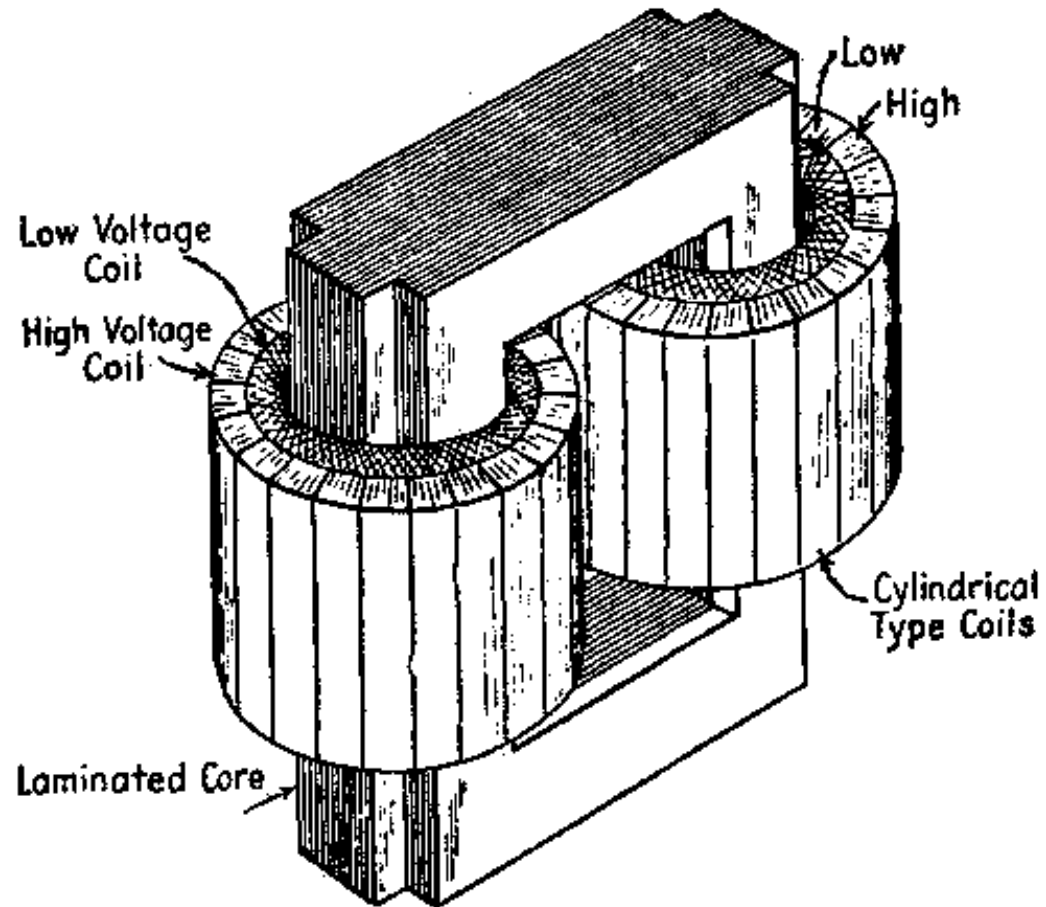

Transformer Hot Spot

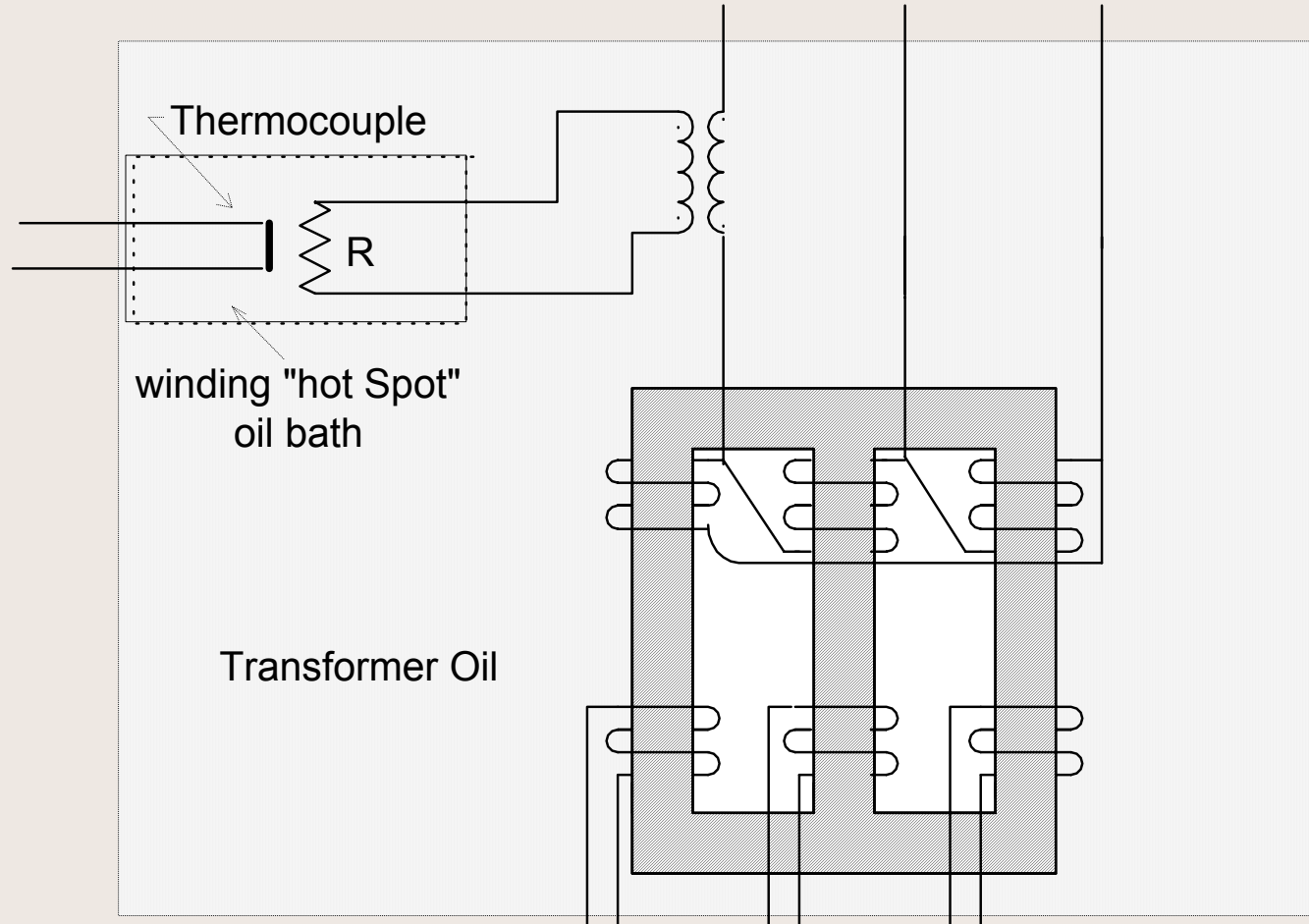

Core Heating

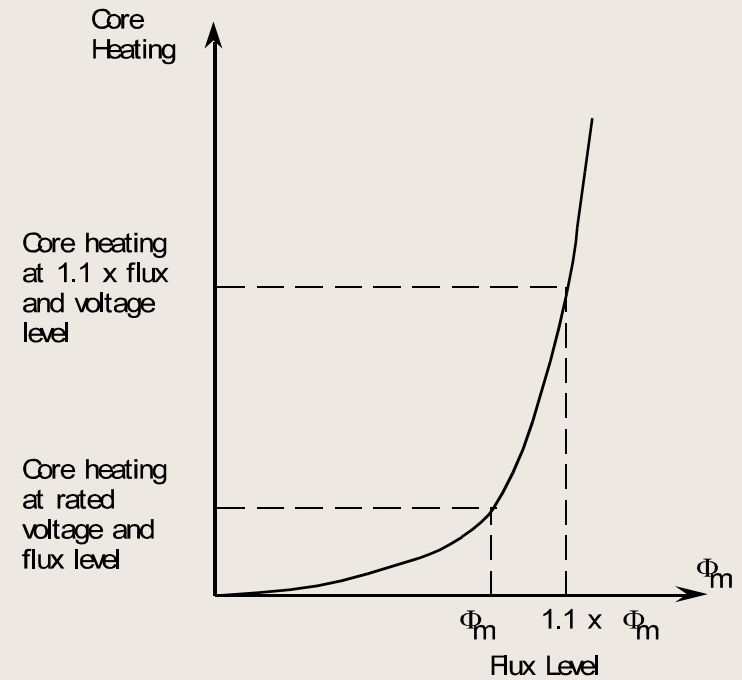
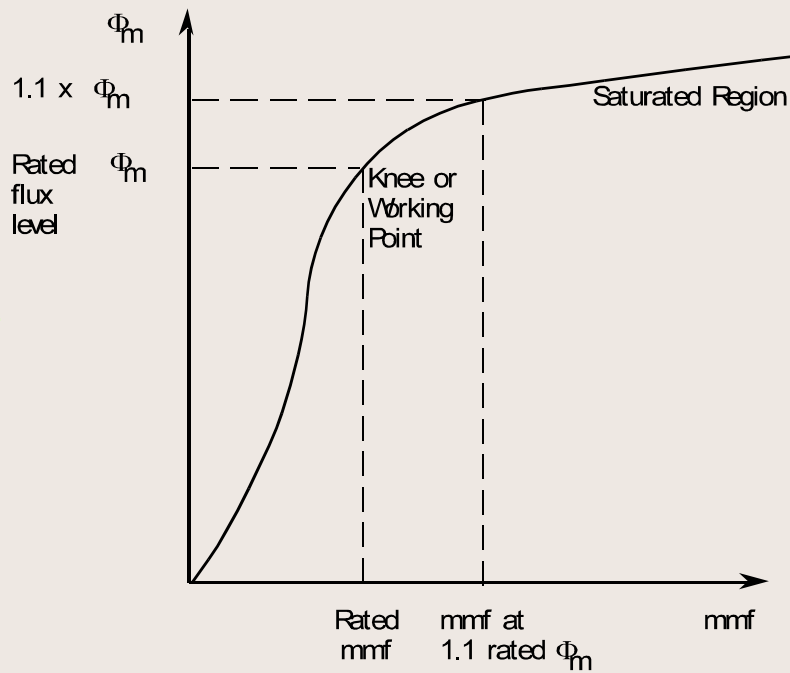

Instrument Transformers

- Step down values to safe levels for measurement
- Potential Transformers
 - Also called voltage transformers
 - Standard output 120V
- Current Transformers
 - Standard output of 1 or 5 amps
 - Metering and relaying standards
 - Can produce high voltages if open circuited

You do the Questions

