

Sterilization of Medical Products

<date/time>

Medical Products

- **Need to be free of pathogenic microorganisms (sterilized) before use**
- **Sterility Assurance Levels (SAL)**
 - **10^{-6} for implants**
 - **10^{-3} for topical products**
- **Products include**
 - **Medical disposables (syringes, gloves)**
 - **Tissue and bone implants (including substitutes)**
- **Sterility also required for pharmaceuticals and cosmetics (information largely with relevant companies)**

Traditional Sterilization Methods

- **Dry heat, 140-170°C, 1-3 h; not applicable to all products**
- **Steam under pressure, 121-132°C, 5-45 min; not applicable to all products**
- **Ethylene oxide (EtO), 25-75°C, 450-1000 mg/L (in Freon, now CO₂), 1-12 h**
 - **Concerns about EtO toxicity/carcinogenicity**
 - **Cost increasing due to tightening regulations**
- **Aseptic processing, SAL 10⁻³**
 - **For limited products (e.g., pharmaceuticals)**
 - **Use decreasing**
- **Radiation Sterilization, room temperature, widely applicable**
 - **Typical dose, 25 kGy**
 - **D_{min} and D_{max} should be determined based on local bioburden and the materials to be used**

Survival of Microorganisms During Radiation Sterilization

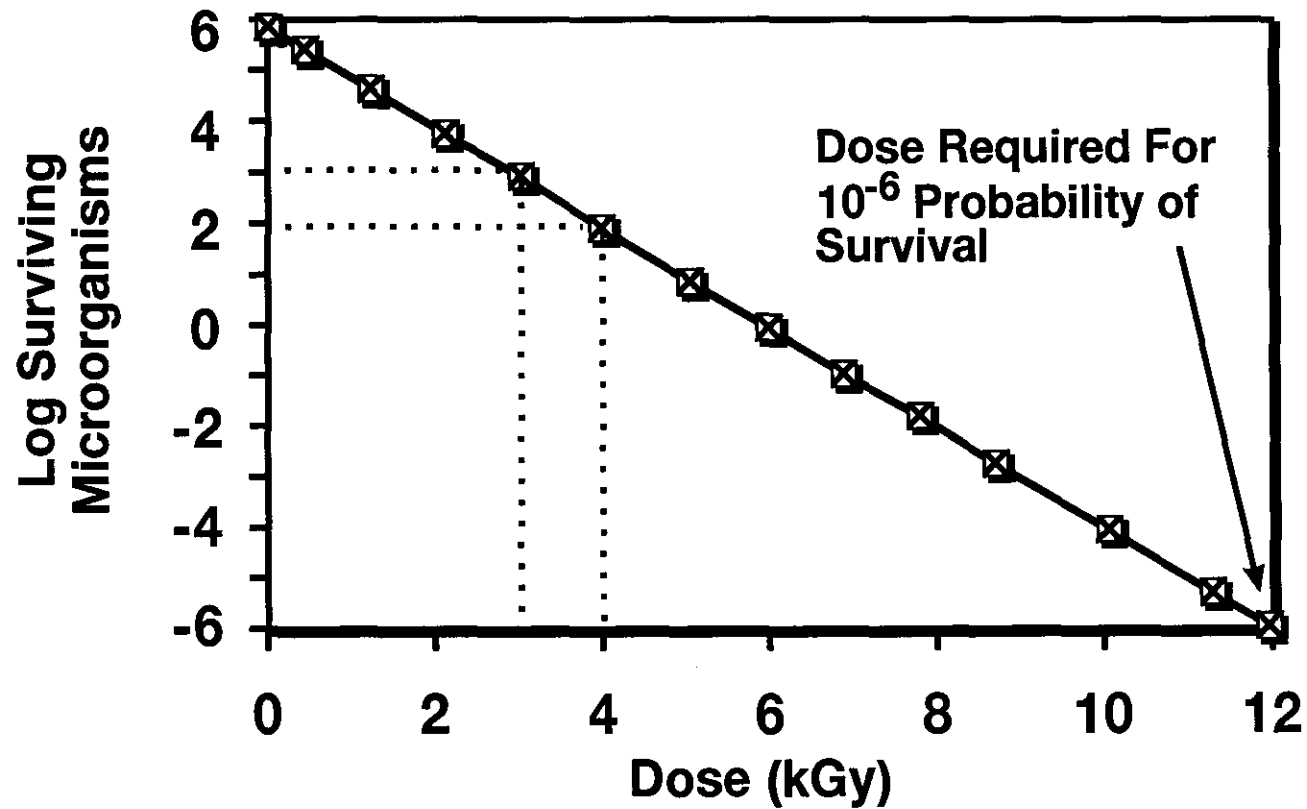

• D_{10} - Value = 1 kGy

International Standards and Protocols for Radiation Sterilization of Medical Devices

North America

AAMI ST 32
“Guideline for Gamma Radiation Sterilization”

AAMI ST 31
“Guideline for Electron Beam Radiation Sterilization of Medical Devices”

International

ISO 11137
“Sterilization of health care products - requirements for validation and routine control - radiation sterilization”

Also see ISO 9001; ISO 9002; ISO 9004

Europe

BS EN 552
“Sterilization of medical devices - validation and routine control of sterilization by irradiation”

**(EN 556; EN 1174-1;
EN 46001; EN 46002)**

Mechanisms of Microbial Inactivation by Sterilization Processes

Process	Mechanisms of Inactivation
Moist heat	Membrane damage, DPA loss, SSB in DNA, protein coagulation, enzyme inactivation
Dry heat	DNA damage; oxidation?
Ionizing radiation	Mainly SSB and DSB in DNA
Ethylene Oxide	SSB in DNA, damages - SH and -NH₂ containing macromolecules

See Morrissey et al. (1993), for details

Microbial Sensitivity to Ionizing Radiation (Morrissey et al., 1993)

Sensitivity	Microorganisms
High	Vaccinia virus T3 Coliphage Many Gram-positive and -negative organisms
Intermediate	<i>Saccharomyces spp.</i> <i>S. typhimurium</i>
Low	<i>D. radiodurans</i> Bacterial Spores <i>Streptococcus faecium</i>^a
Very Low	Prions

^a When dried from serum broth

Microbial Sensitivity to Electron vs Gamma Irradiation (Liquid Suspension)

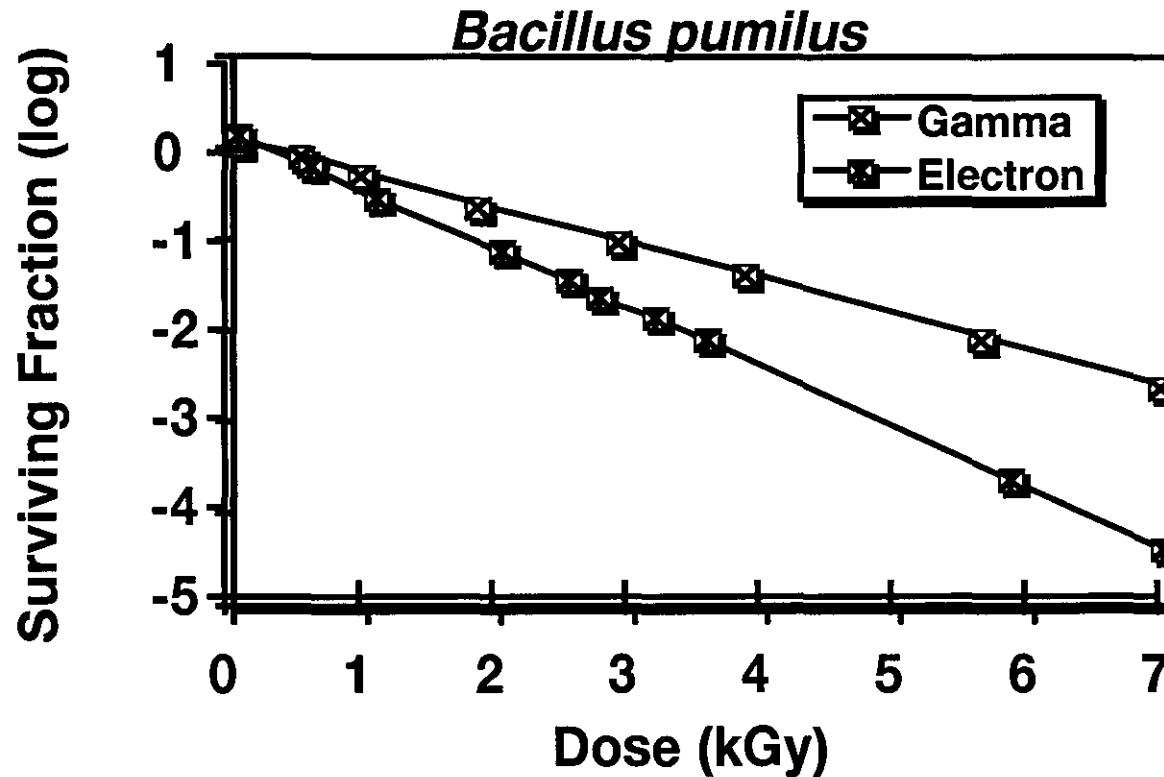

- The data (D_{10} -values) favour use of electrons marginally for this bacteria

Microbial Sensitivity to Electron vs Gamma Irradiation (Liquid Suspension)

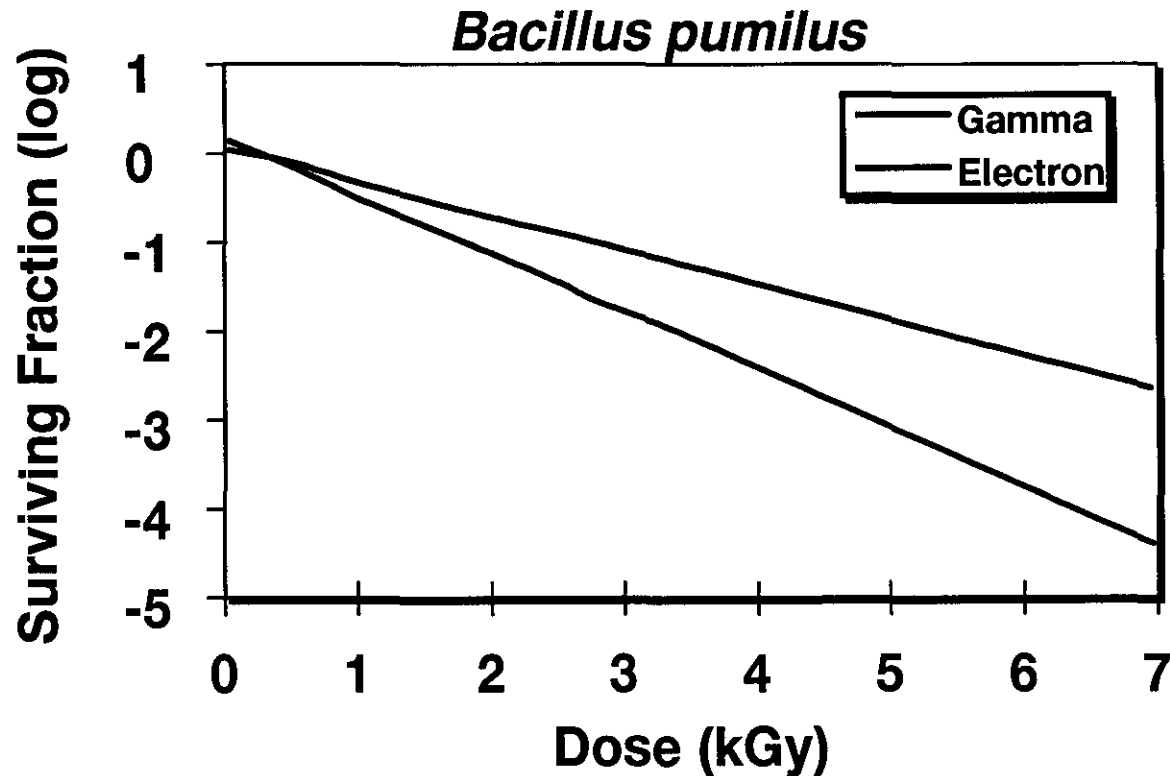

- The data (D_{10} -values) favour use of electrons marginally for this bacteria

Microbial Sensitivity to Electron vs Gamma Irradiation (Dried Film)

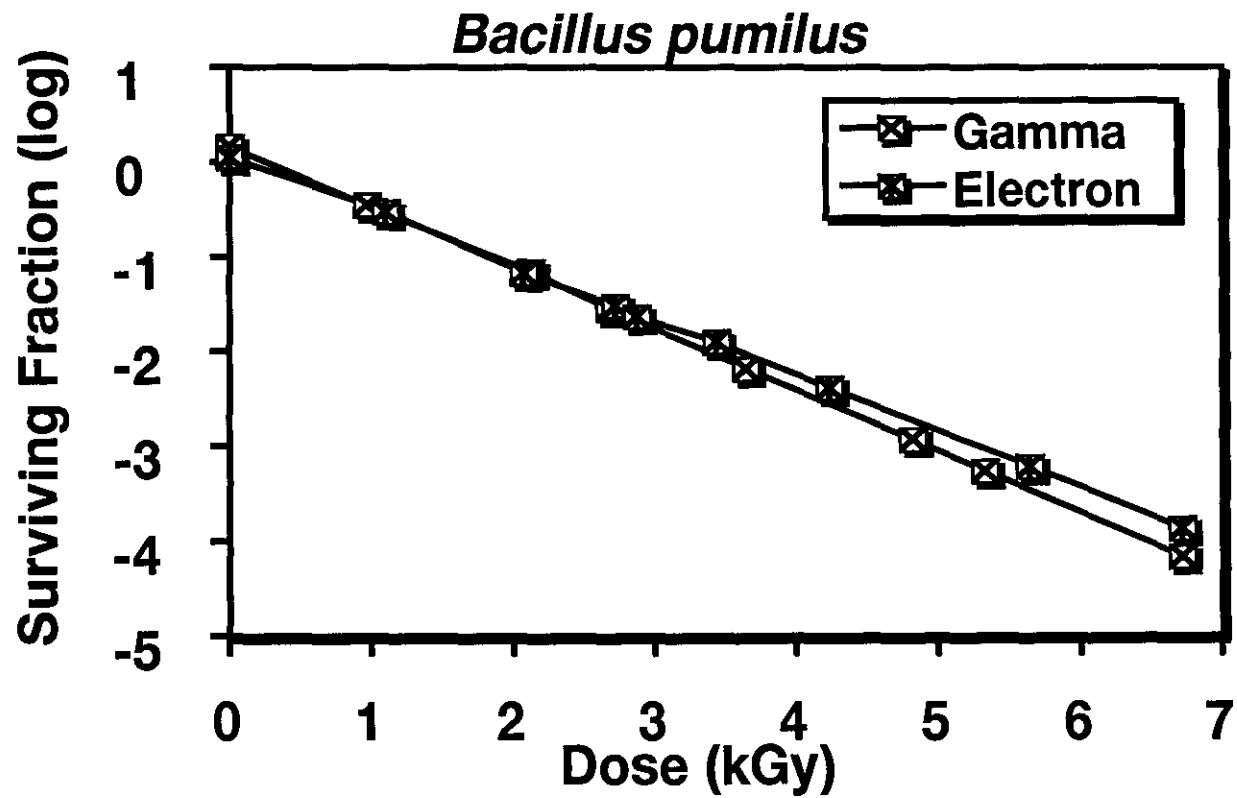

Microbial Sensitivity to Electron vs Gamma Irradiation (Dried Film)

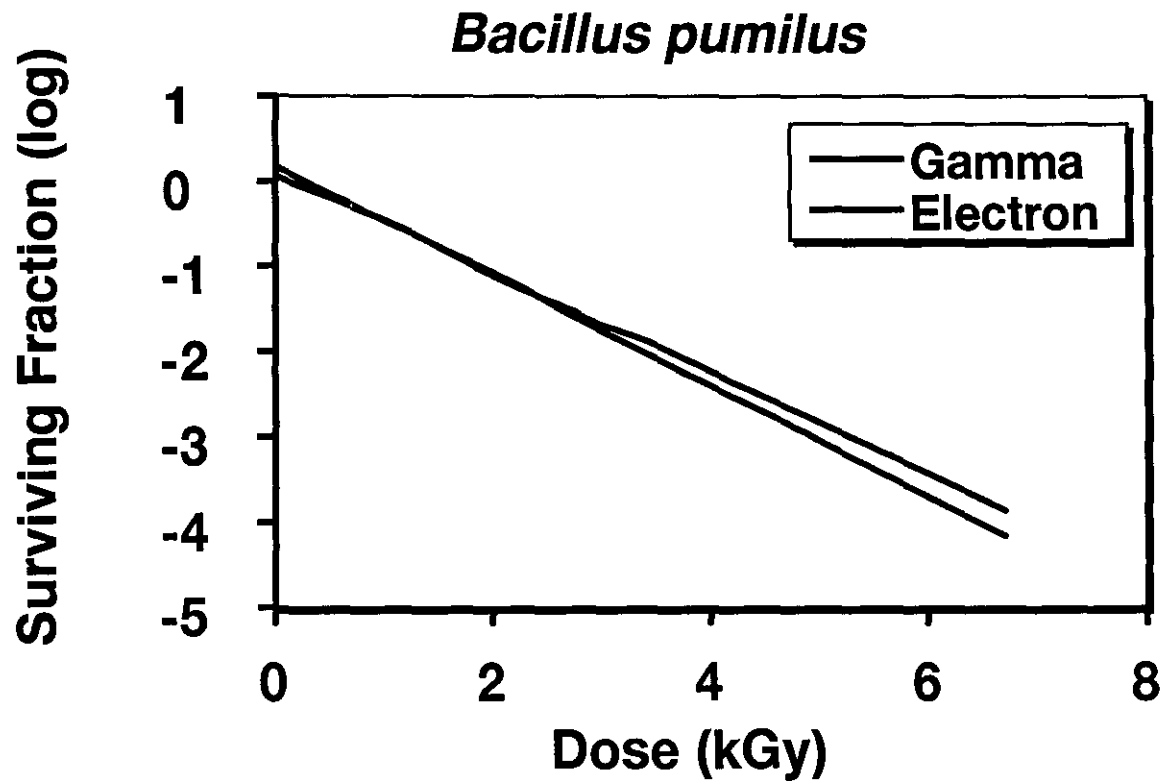

Effect of Dose Rate^a

Type of Spore or Bacteria	D ₁₀ Value (kGy)		Sterilization Dose ^b (kGy)	
	Gamma	E-Beam	Gamma	E-Beam
<i>Clostridium sporogenes</i> B-9	2.01	1.92	16.1	15.4
B-10	2.57	1.99	20.6	15.9
<i>Listeria monocytogenes</i> Scott A	0.24	0.23	1.9	1.8
81-861	0.45	0.20	3.6	1.6
<i>Escherichia coli</i>	0.43	0.17	3.4	1.4

^a Saunders et al. (1993)

^b Based on a sterility assurance level (SAL) of 10⁻⁶ and an initial bioburden of 100 organisms/unit

Radiation-Induced Oxidation of Polymers

**G-Value of Oxygen Consumption at Room Temperature
under ~ 70 kPa Oxygen (Kashiwabara and Seguchi, 1992)**

Polymer	Dose (kGy)	Dose Rate (kGy/h)	G(-O₂)
Low-density polyethylene	500-1000	10	14
High-density polyethylene	500-1000	10	18
Medium-density polyethylene	500-1000	10	18
Ethylene propylene rubber	100-500	2	8
Isotactic polypropylene	100-200	10	50
Polyvinyl chloride	100-200	10	29
Polyvinyl chloride (stabilized)	100-200	10	11

Effect of Electron and Gamma Irradiation on the Colour of Polycarbonate Resin

Dose (kGy)	Electron Yellowness Index	Gamma Yellowness Index
0	-	1.2
10	1.0	8.4
40	1.6	26.4

- **The level of colour developed varies from polymer to polymer, and also depends on the stabilizers used**

Chemical Basis of Oxidative Degradation

• *Initiation*

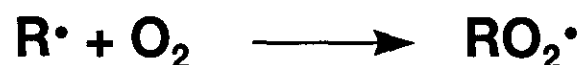

• *Crosslinking*

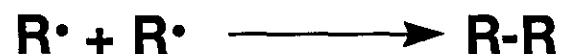

(not favoured in air/oxygen)

• *Degradation*

$\text{RO}_2\cdot$, ROOH \longrightarrow Chain scission, degradation,
alcohols, ketones

Propagation, Chain Reaction and Post-Irradiation Degradation of Polymers

- Oxidative degradation of polymers reduces strength and flexibility, causes cracking, increases moisture uptake and degrades electrical insulation properties

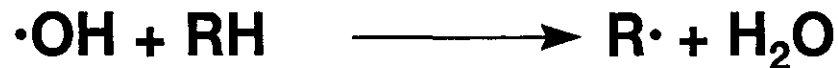
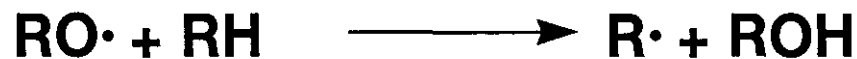
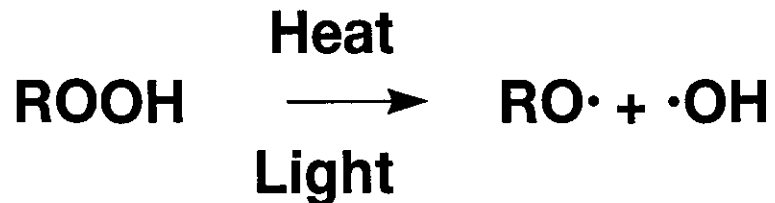
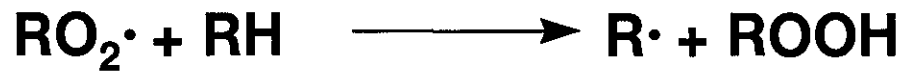

- Oxidative degradation usually continues for months after irradiation, e.g., initiated by the reactions of ROOH

Chemical Formulae of Some Antioxidants (Kashiwabara and Seguchi, 1992)

Symbol

Name and formula

DPPD

N,N'-Diphenyl-p-phenylenediamine

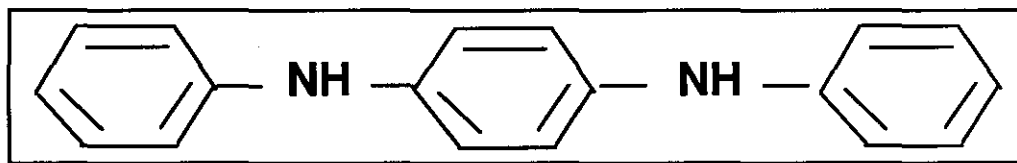

Irganox 1010

Tetrakis[methylene-3(3,5-di-t-butyl-4-hydroxyphenyl) propionate]methane

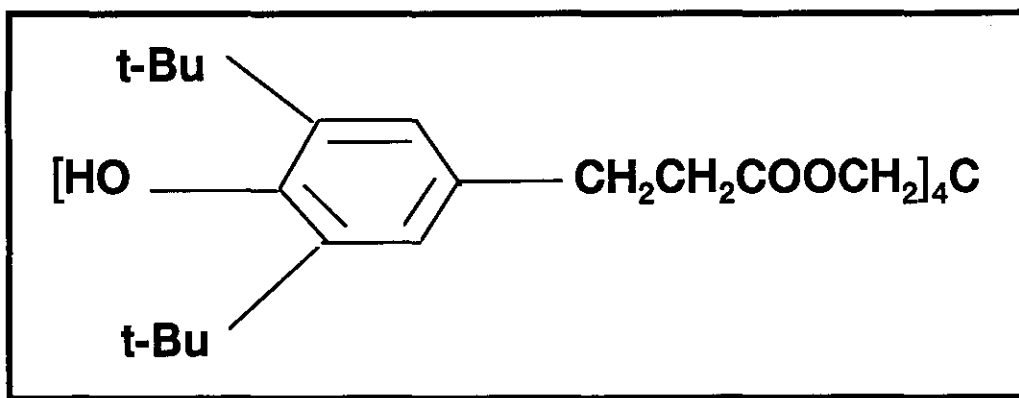

- Use of antioxidants, and mobilizers (e.g. mineral oils), reduces radiation-induced damage to most polymers

Radical Buildup and Decay in Gamma Irradiated Polypropylene in Air

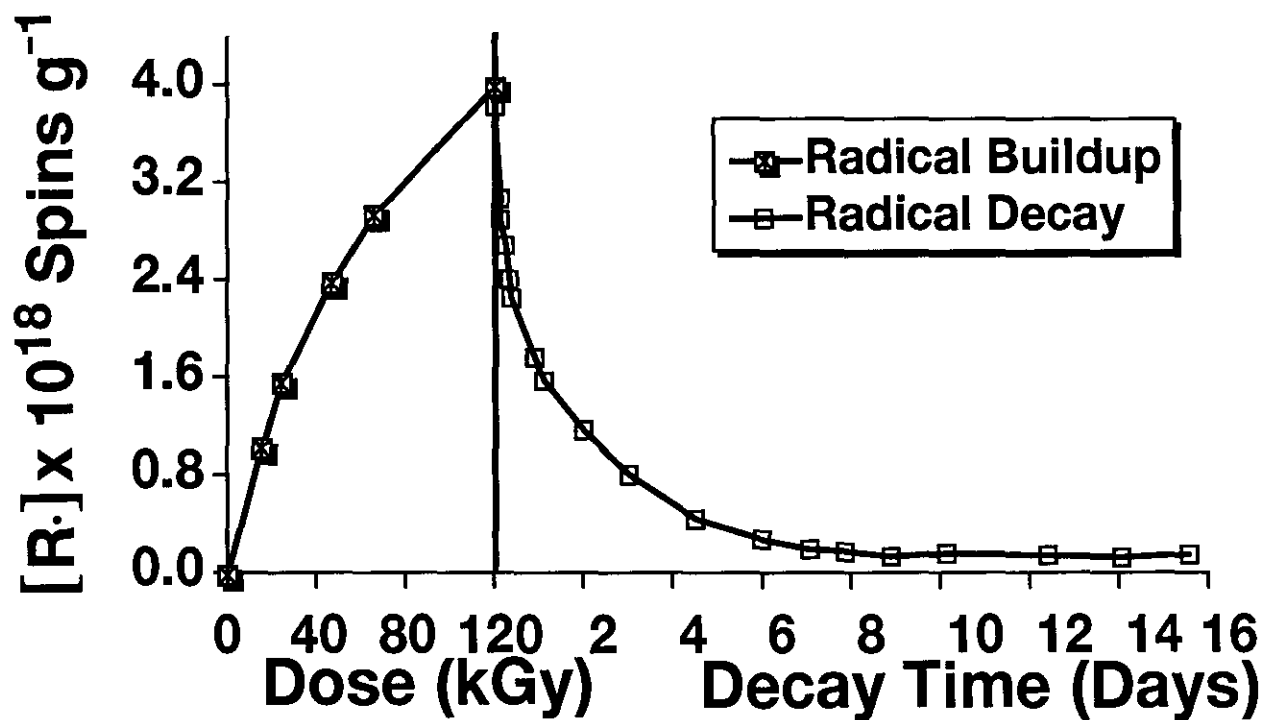

Kashiwabara and Seguchi, 1992

Effect of Dose and Dose Rate on the Tensile Strength of Polypropylene

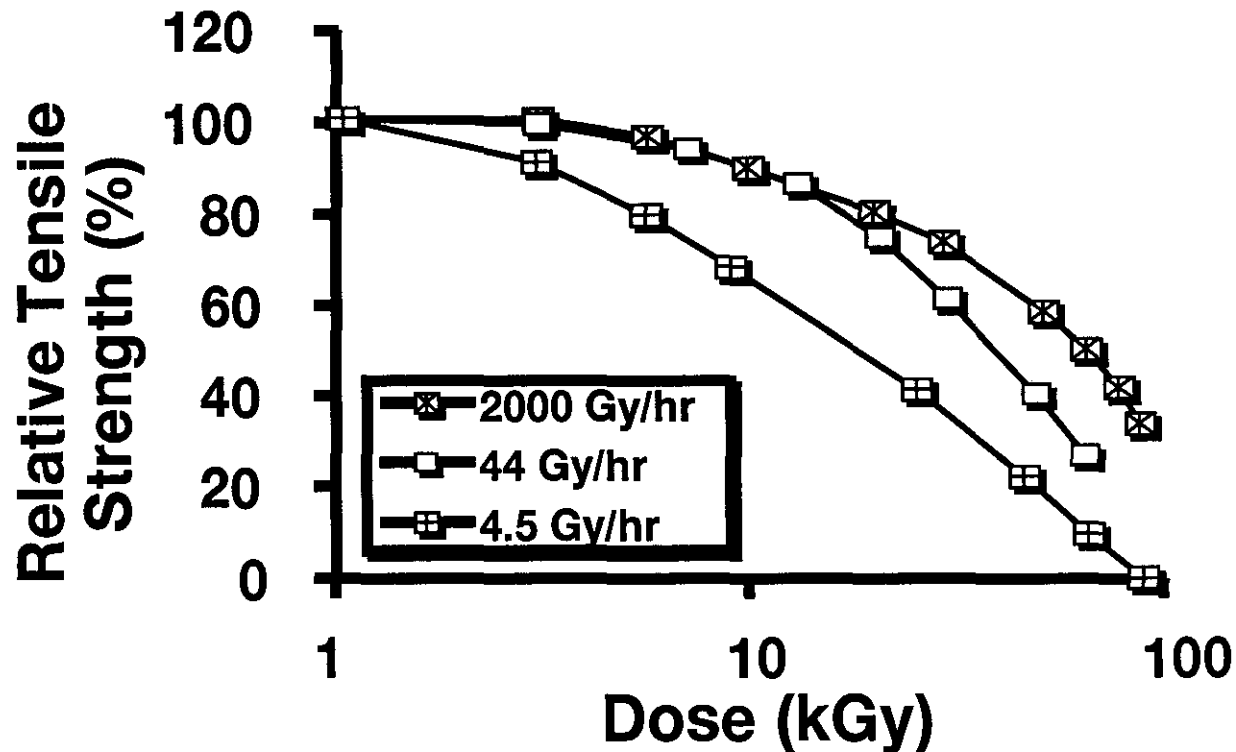

- In general, the mechanical properties of polymers are less adversely affected on electron irradiation, as compared to gamma irradiation
- Satisfactory stabilized polymers for both types of irradiations are available

Effect of Mobilizing Agent on Polypropylene

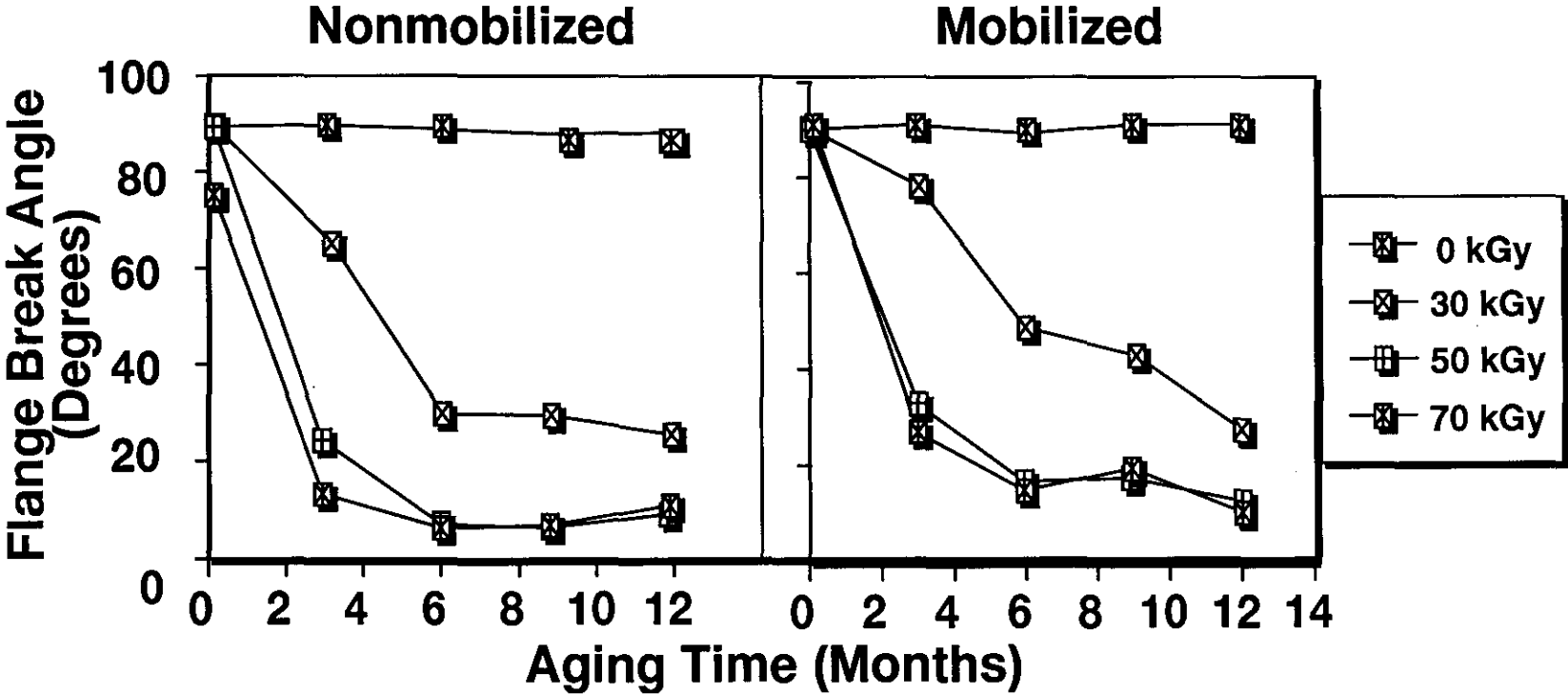

Effect of Radical Scavenger and Mobilizing Agent on Polypropylene

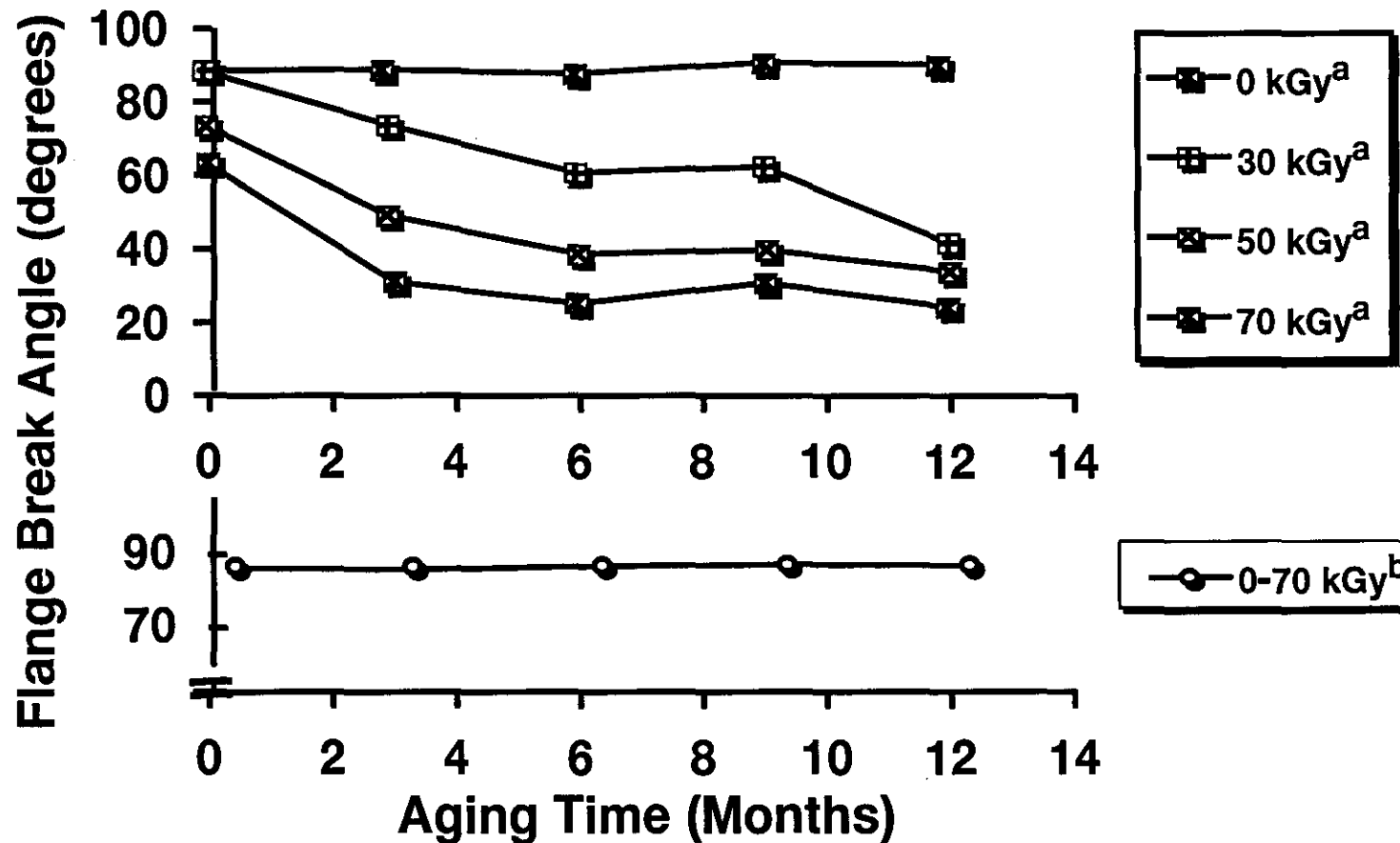

a. Radical scavenger, b. Radical scavenger + mobilizing agent

Dose Dependence of Oxygen Consumption in EPR Containing DPPD Antioxidant

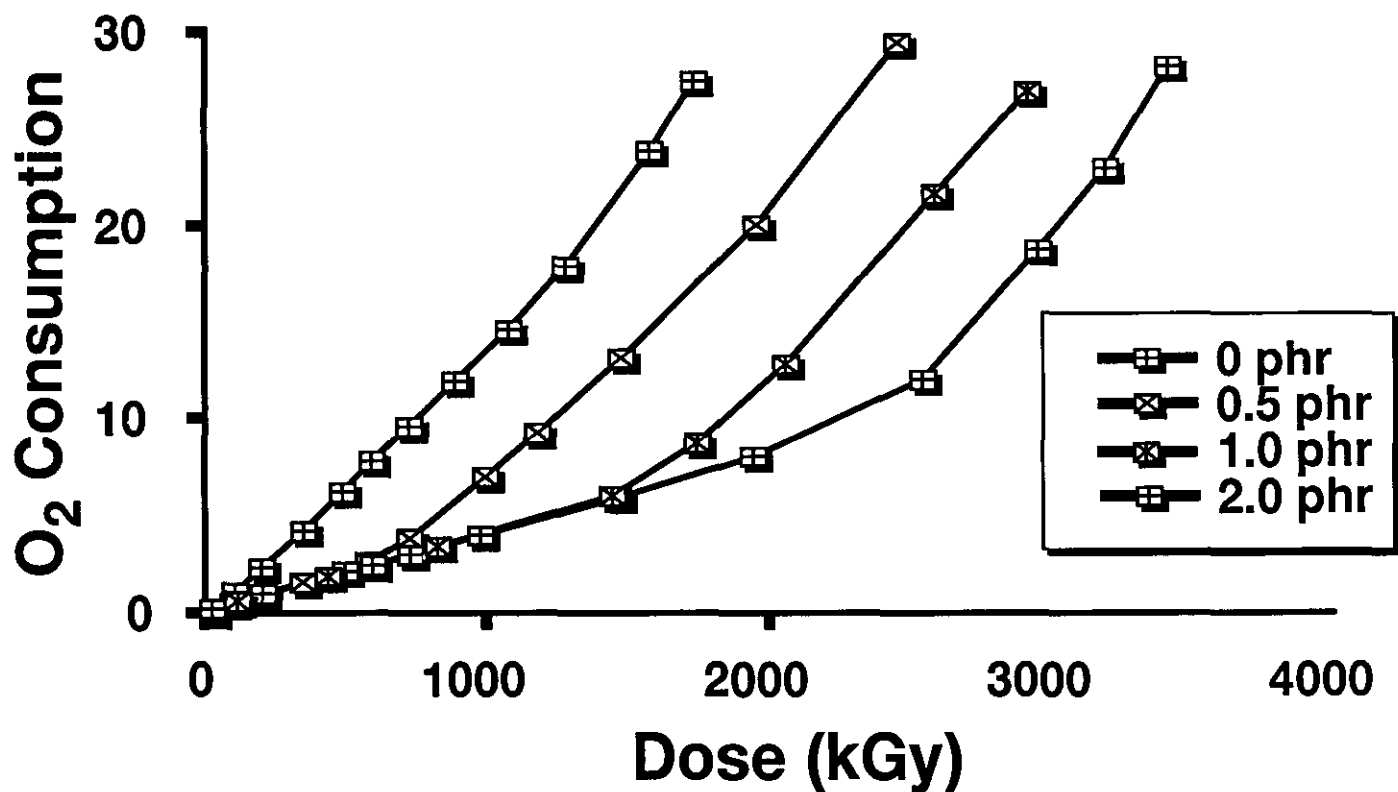

Material Qualification

- **Since a large component of medical disposables and devices is made of plastics, it is important to establish that at D_{\max} , the materials irradiated would have the required mechanical properties**
- **Since oxidative degradation can continue after irradiation has been completed, the aging characteristics (shelf-life) of the materials also need to be established**

Product/Process Validation

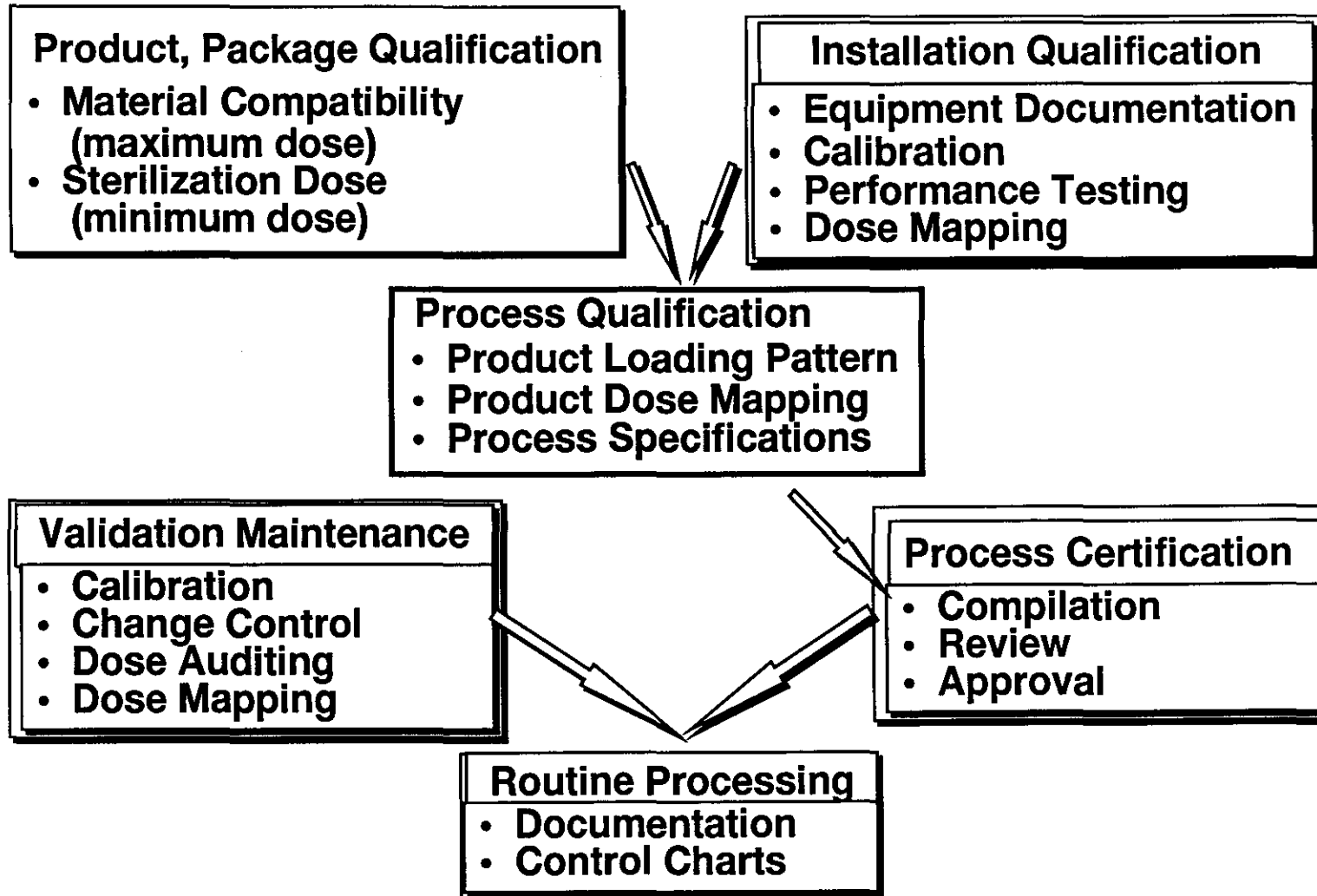

Facility and Installation Validation

- **Both EN 552 and ISO 11137 specify carrying out standard dose maps**

The key parameters to consider include

- **Energy**
- **Beam Current**
- **Scan Width**
- **Scan Uniformity**
- **Conveyor Speed**

Their values should be related to measured dosimetry values

- **Dose mapping to be repeated after any intervention (service, repair, re-calibration) that could change the settings**

Machine Performance Validation

The key parameters for electron accelerators are

Beam Energy - (Depth/Dose)

Beam Current - (Calorimetry)

Scan Width - (Relative Dosimetry)

Scan Uniformity - (Relative Dosimetry)

Product Speed Control - (Relative Dosimetry)

Characterization of the Irradiator

Source: e^- γ

- Determine depth/dose curves with a wedge Yes Yes

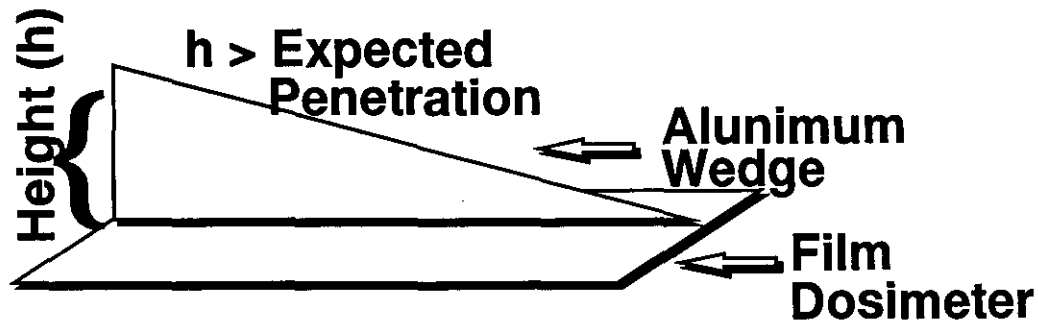

- Determine dose profile Yes Yes

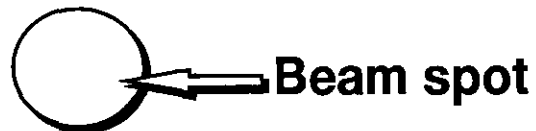

Characterization of the Irradiator

Source: e^-

γ

- Determine Dose Profile

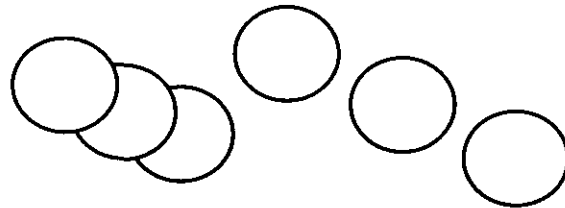

← Scan

Yes

Yes

- Determine Nominal Dose Received by Product

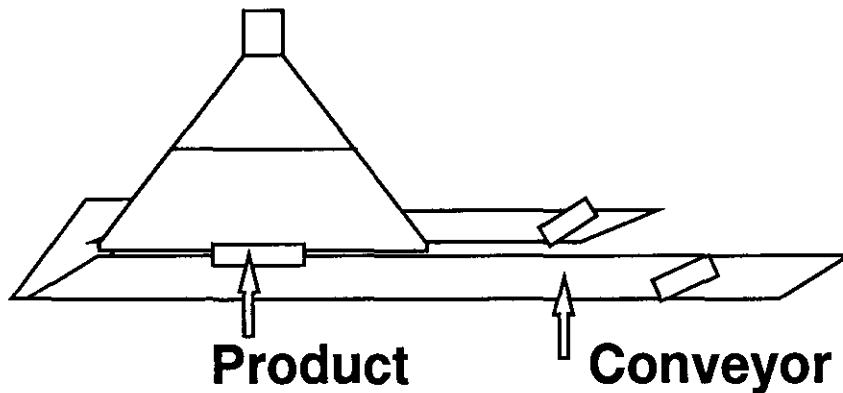

Yes

Yes

Required Dose Settings

- **Important to determine the minimum and maximum (D_{\min} and D_{\max}) dose required for radiation sterilization of medical products, under local conditions of bioburden and materials availability, using the local (or very similar) irradiator**
- **Dose settings are not transferable from gamma to electron irradiation and may not be transferred from one electron irradiation plant to another (ST 31 2.2)**
- **Generating the required knowledge requires access to the electron irradiator which is to be used for processing (EN 552 4.2.1)**
- **Transfer of sterilization dose between two electron irradiation facilities must be supported by data showing that the microbial inactivation is not affected by any differences in source characteristics, particularly in energy, dose rate or dose distribution (ISO 11137)**

Product Validation

- 1. Establish Dose Distribution, critical monitoring locations and D_{\max}/D_{\min} ratio**
- 2. Using dosimeter calibration data and required confidence level, set target D_{\min}**
- 3. Establish materials compatibility at resulting D_{\max}**
- 4. Record key processing parameters - for example conveyor speed, scan width setting, beam energy and current**
- 5. Establish procedures for ensuring material and packing reproducibility, and reproducibility of the loading pattern**
- 6. Set dose and product monitoring frequency to be used during normal processing**

Dose Map for 30 mL Syringes 1 Box Deep (Single Sided)

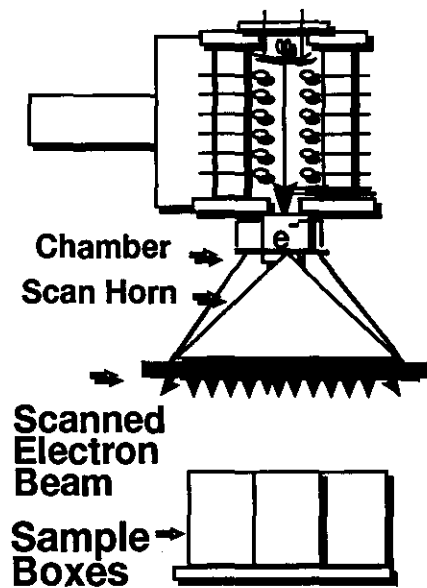

	Dosimeter 1	2	3	4	5	6
Syringe						
1	21.8	26.9	20.3	28.3	25.9	22.4
2	16.9	26.1	21.8	25.0	29.2	24.2
3	23.4	25.3	18.3	19.0	26.7	23.7
4	24.8	31.7	<u>16.5</u>	31.7	23.7	26.9
5	23.2	30.9	18.8	26.4	29.2	26.7
6	22.4	25.6	21.1	22.4	30.0	<u>36.1</u>

Boxed Syringe
with dosimeters

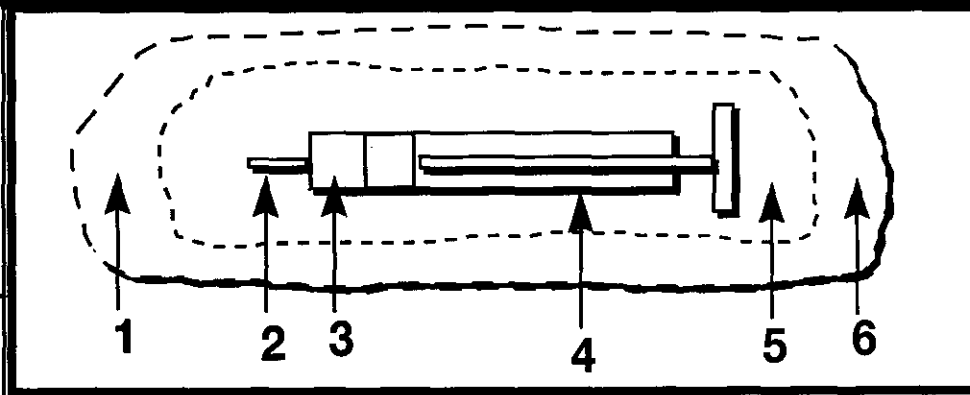

• $D_{\max} / D_{\min} = 36.1 / 16.5 = 2.19$

Dose Map for 30 mL Syringes 2 Boxes Deep (Double Sided)

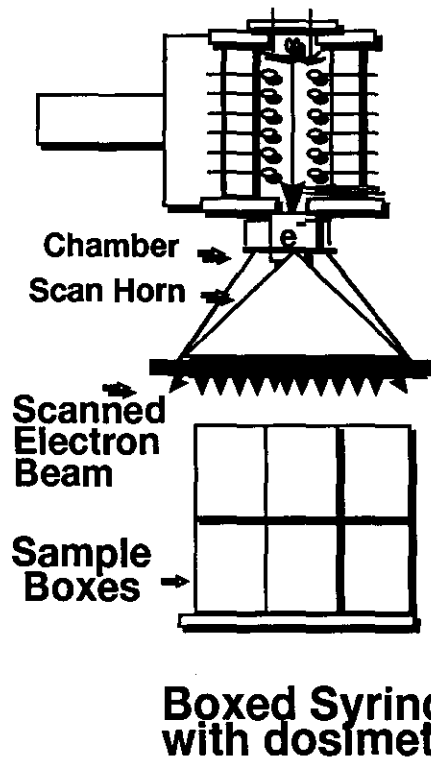

Dosimeter	1	2	3	4	5	6
Syringe						
1	<u>37.3</u>	41.3	38.5	42.5	40.3	43.1
2	47.6	49.5	<u>50.8</u>	44.1	42.8	46.3
3	38.8	41.3	37.6	39.7	41.6	44.1
4	47.6	44.1	46.3	41.6	40.7	46.3
5	47.6	49.5	43.4	38.5	43.8	43.8
6	47.9	43.4	44.4	46.3	45.3	45.3

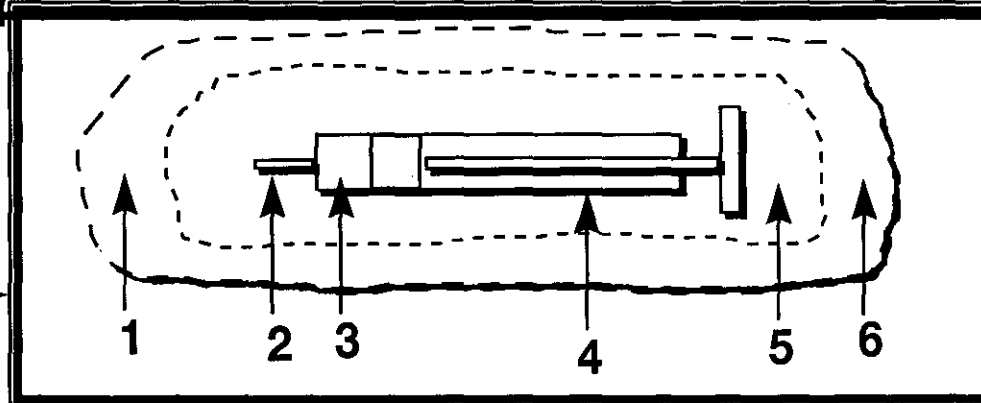

• $D_{\max} / D_{\min} = 50.8 / 37.3 = 1.36$

Process Control

Continuous monitoring of the following items is desirable

**Beam Energy
Beam Current
Scan Width
Conveyor Speed
Product Loading
Product Position
Product ID and Layout
Product Location**

Periodic analyses of the irradiated product should be part of the quality assurance programme

Plant Capacity and Processing Rates

For Gamma Irradiation

$${}^{60}\text{Co Required} = \frac{18.74 \times \text{Dose in kGy} \times \text{kg/hr}}{1,000,000 \times \text{Plant Utilization Efficiency}^*} \text{ MCi}$$

* working value of 25% used for these calculations

For Electron Irradiation

$$\text{Beam Power Required} = \frac{\text{Dose in kGy} \times \text{kg/hr}}{3600 \times \text{Plant Utilization Efficiency}^\dagger} \text{ kW}$$

† working value of 30% used for these calculations

- Use average density of the packaged product to calculate cost/unit
- Average density of many medical disposable packages, ~ 0.15

Plant Efficiency

1. D_{\max}/D_{\min}
 2. Product Thickness
 3. Box-to-box and tray(carrier)-to-tray(carrier) spacing
 4. Equipment availability - reliability
 5. Product and handling efficiency (receiving, shipping and irradiation)
- General rule for a multi-purpose plant is to assume 30% overall efficiency until there is good data that supports a different figure

Items to be Considered for Capital and Other Fixed Costs

- 1. Electron Beam Accelerator/Gamma Irradiator**
- 2. Product Handling, Process Control and Tracking System**
- 3. Shielding - and the overall building (e.g. control room, testing laboratory, office space, warehouse)**
- 4. Safety System**
- 5. Cooling System**
- 6. Ventilation System**
- 7. Electricity Sub-Station**
- 8. Instrumentation, tools and equipment**

Cost vs Power of 10 MeV Accelerators

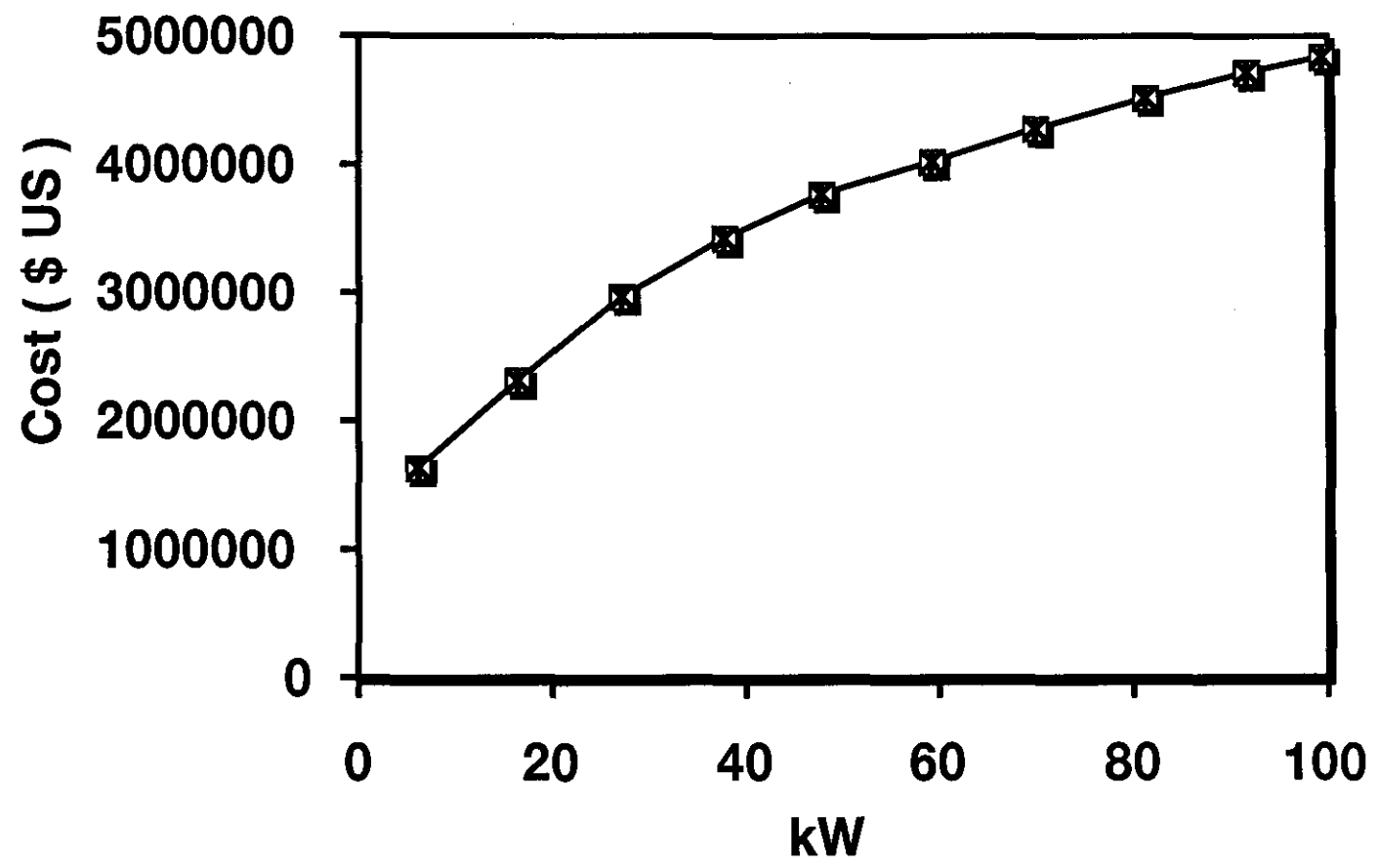

Capital Cost per kW of Electron Accelerator (10 MeV)

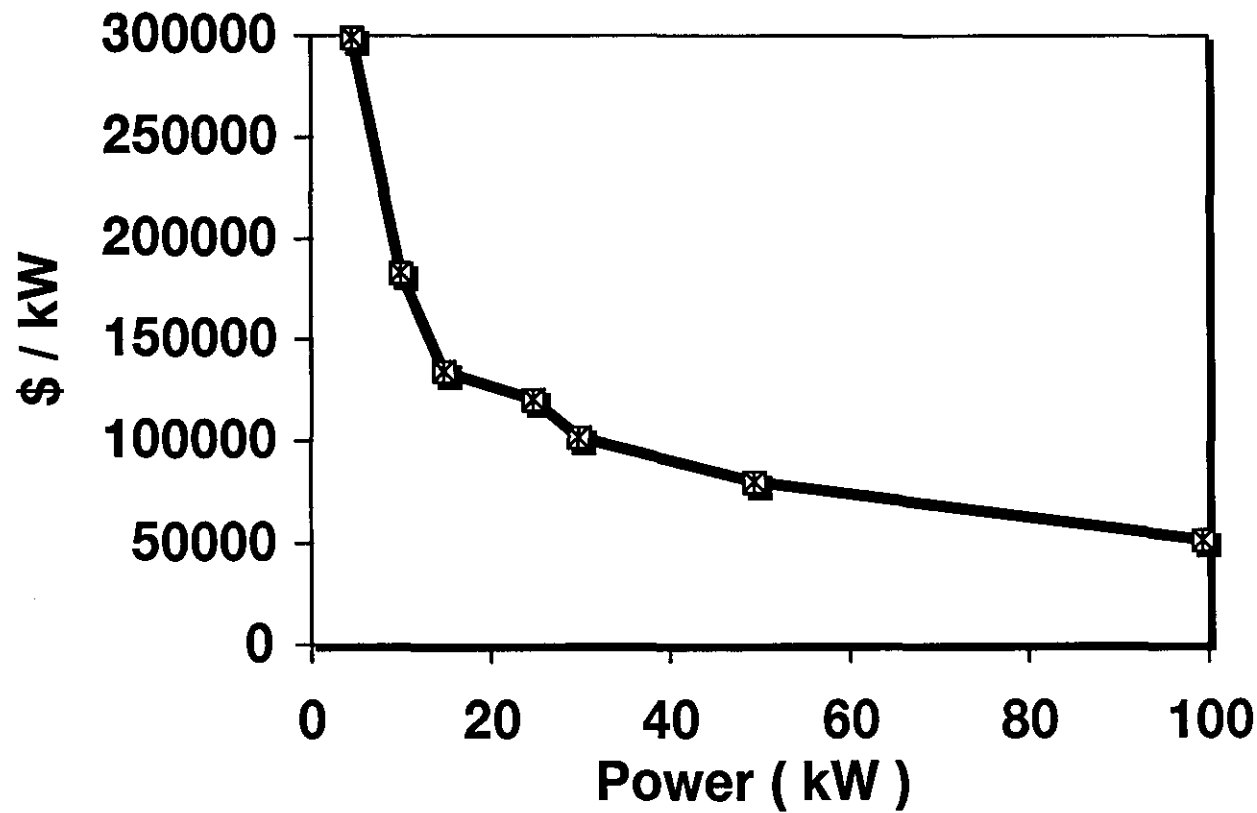

Operating Costs

- 1. Workers (including management)**
- 2. Electricity**
- 3. Rf tube Replacement/⁶⁰Co Replenishment**
- 4. Maintenance**
- 5. Dosimetry**
- 6. Periodic Process Validation**

Cost Comparison (Units of 1000\$ US) Electron vs Gamma Irradiation (Based on Morrissey et al., 1993)

Cost	Gamma	Gamma	Electron	Electron
Source	3,500 (2 MCi)	1,750 (1MCi)	3,000	3,000
Building, Conveyor, etc.	4,500	4,500	4,500	4,500
Total	8,000	8,000	7,500	7,500
Maintenance / Operating	2,245	1,630	1,940	1,550
Hours of Operation /a	8,000	8,000	8,000	4,000
Unit Cost (\$/cu ft)	0.70	1.03	0.60	0.98

- The cost of gamma irradiation for 0.5 MCi source is lower (\$1.60) than for electron accelerator running for only 2000 h/a (\$1.70)

Comparison of Electron, X-Ray and Gamma Irradiation (Based on Morrissey et al., 1993)

Quality	Electrons	X-Rays	Gamma Rays
Product compatibility	+	+	-
Short exposure times	+	+	-
Quick product changes	+	+	-
Variable parameters	+	+	-
Radiation utilization	+	+	-
High throughput rates	+	0	-
Intermittent operation	+	+	-
Conveyor simplicity	+	+	-
Dose uniformity	-	0	+
Process validation	_a	_a	+
Product validation	_a	0 ^a	+
Process control	_a	_a	+
Equipment maintenance	-	-	+
Unit processing cost	+	0	-
Radiation safety	+	+	-

+ Better, 0 Similar, - Poorer; a, probably better than the rating here

Conclusions

- **Radiation sterilization is the method of choice for most medical products**
- **The use of ethylene oxide appears to be declining due to its toxicity and associated regulations**
- **Gamma irradiation has a good established position in this industry**
- **Electron irradiation of medical products is growing, probably more rapidly than gamma irradiation**